

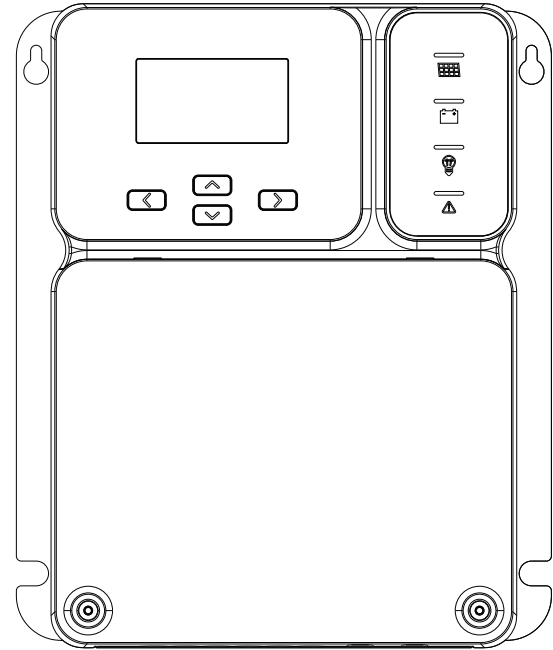







MPPT Solar Charge Controller User Manual



Dear users, Thank you for choosing our product!

Safety Instructions

-  1. As this controller deals with voltages that exceed the top limit for human safety, do not operate it before reading this manual carefully and completing safety operation training.
-  2. The controller has no internal components that need maintenance or service, thus do not attempt to disassemble or repair the controller.
-  3. Install the controller indoors, and avoid component exposure and water intrusion.
-  4. During operation, the radiator may reach a very high temperature, therefore install the controller at a place with good ventilation conditions.
-  5. It's recommended that a fuse or breaker be installed outside the controller.
-  6. Before installing and wiring the controller, make sure to disconnect the photovoltaic array and the fuse or breaker close to the battery terminals.
-  7. After installation, check if all connections are solid and reliable so as to avoid loose connections that may give rise to dangers caused by heat accumulation.

 **Warning:** means the operation in question is dangerous, and you should get properly prepared before proceeding.

 **Note:** means the operation in question may cause damage.

 **Tips:** means advice or instruction for the operator.

Contents

1. Product Introduction	03
1.1. Product overview	03
1.2. Product features	03
1.3. Appearance and interfaces	04
2. MPPT Introduction	04
3. Technical Parameters	05
4. Charging	06
4.1. Charging of lead-acid battery	07
4.2. Charging of lithium battery	07
4.3. Current limiting charging	08
5. Battery Temperature Sampling and Control	08
6. Loss Compensation of Battery Voltage Line (some models)	08
7. Load output	08
8. Menu	09
8.1. View menu	09
9. Parameter Setting	10
9.1. Battery parameter list	10
9.2. Parameter setting list	11
9.3. Battery type (n01)	12
9.4. Equalizing charging\boost charging\floating charging\charging reconnect voltage \over-discharge reconnect voltage\over-discharge voltage (n02-n07)	12
9.5. System voltage (n08)	12
9.6. Charging current (n09)	12
9.7. Full-charging setting (n10)	13
9.8. Lead-acid battery constant voltage output (n11)	13
9.9. Light control voltage (n12)	13
9.10. Light control delay (n13)	13
9.11. Load mode (n14)	13
9.12. Load short-circuit protection switch (n15)	14
9.13. Load pre-start time (n16)	14
9.14. Over-discharge delay (n17)	14
9.15. Temperature unit (n18)	14
9.16. RS485 communication baud rate (n19)	15
9.17. Device address (n20)	15
9.18. RS485 function selection (n21)	15
9.19. System reboot (n22)	15
9.20. Reset controller (n23)	16
9.21. Clear history (n24)	16
10. Parallel Application	16
11. TTL Communication	16
12. RS485 communication	16
13. Keys	17
14. Indicator	17
15. System Alarms	18
16. Common Problems and Solutions	19
17. Product Installation	19
17.1. Precautions for installation	19
17.2. Installation steps	20
18. Protection Functions	21
19. System Maintenance	21
20. Product Dimensions	21
21. System Wiring Diagram	22
21.1. Single application wiring diagram	22
21.2. Parallel application wiring diagram	22

1. Product Introduction

1.1 Product overview

The MA series controller adopts the industry-leading MPPT to achieve the maximum energy tracking for the solar panel, that is, it can quickly and accurately track the maximum power point of the solar battery under any condition, and obtain the maximum energy of the solar panel in real time, significantly improving the energy utilization rate of the solar system. The controller is widely used as the core control component in the off-grid PV systems to manage the work of solar panels, batteries, and loads. The controller has complete software and hardware fault detection and protection functions to avoid damage to product components caused by installation errors and system faults to the greatest extent.

1.2 Product features

- ◆ Adopt MPPT with tracking efficiency up to 99.9%.
- ◆ Support full-power charging and discharging at one time.
- ◆ Support multiple battery types such as sealed battery, gel battery, flooded battery, lithium battery and user-defined battery.
- ◆ Support lithium battery and lead-acid activated battery.
- ◆ Support the charging current setting.
- ◆ Support full settings.
- ◆ Support temperature compensation.
- ◆ Support parallel charging (some models).
- ◆ Support charging voltage line loss compensation, so that the control of battery charging voltage is more accurate (some models).
- ◆ Support 17 kinds of load operating modes.
- ◆ Support capacitive loads and inductive loads.
- ◆ Save 300 consecutive days of historical data.
- ◆ Support RS485 communication of standard Modbus protocol with adjustable baud rate.
- ◆ Support TTL communication of standard Modbus protocol with fixed baud rate.
- ◆ Support CAN communication (optional).
- ◆ Possess complete charging and discharging protection mechanisms for overvoltage, overcurrent, overload, over-temperature, short circuit, etc.
- ◆ Adopt high-quality aluminum radiator and high-temperature derating treatment to ensure reliable and efficient operation in various operating conditions.

1.3 Appearance and interfaces

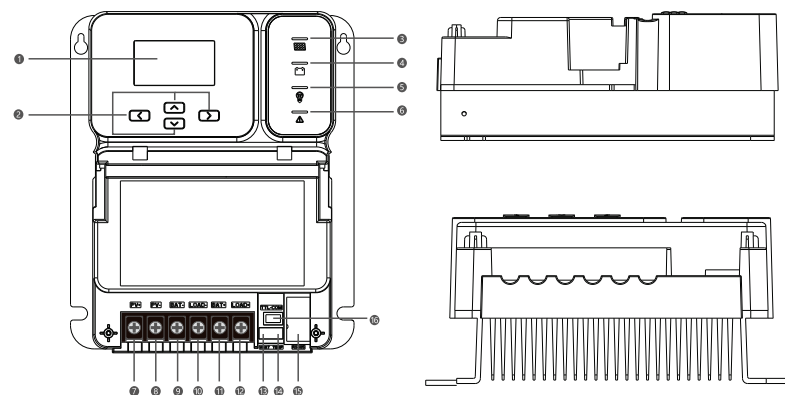

No.	Name	No.	Name
①	LCD (backlit)	⑨	Battery negative port
②	Key	⑩	Load negative port
③	Charge indicator	⑪	Battery positive port
④	Battery indicator	⑫	Load positive port
⑤	Load indicator	⑬	Battery voltage compensation port (some models)
⑥	System alarm indicator	⑭	Temperature sensor port
⑦	Solar battery positive port	⑮	RS485 isolation communication port
⑧	Solar battery negative port	⑯	TTL communication port

1.4 MPPT Introduction

MPPT (Maximum Power Point Tracking) is an advanced charging technology that enables the solar battery to output more electrical energy by adjusting the operating state of the electrical module. Due to the nonlinearity of the solar battery array, there is a maximum power point on its curve. The PWM charging technology used in the traditional controller cannot charge the battery continuously at the point, so it cannot obtain the maximum energy of the solar panel. Instead, the solar controller with MPPT can always track the maximum power point of the array, so as to charge the battery with maximum energy. For example, for the 12V solar system, since the peak-to-peak voltage (Vpp) of the solar battery is about 17V, but the battery voltage is about 12V, therefore, when the common charge controller is charging the battery, the voltage of the solar battery is about 12V, that is, the solar battery does not fully exert its maximum power.

The MPPT controller can overcome the problem and adjust the input voltage and current of the solar panel in real time to reach the maximum input power. Compared with the traditional PWM controller, the MPPT controller can exert the maximum power of the solar battery, so it can provide a larger charging current. Generally speaking, the MPPT controller can improve the energy utilization rate by 15%~20% more than the PWM controller.

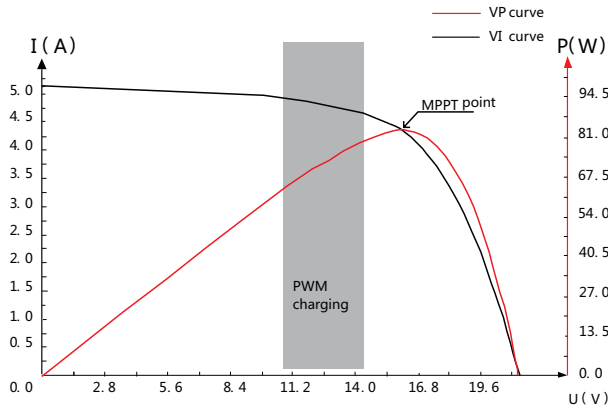

Figure 1-2 Battery panel output characteristic curve

Due to the different ambient temperature and lighting conditions, the maximum power point often changes, and our MPPT controller can adjust the parameters in real time under different conditions, thus making the system is always near the maximum operating point. The whole process is completely automatic without any adjustment.

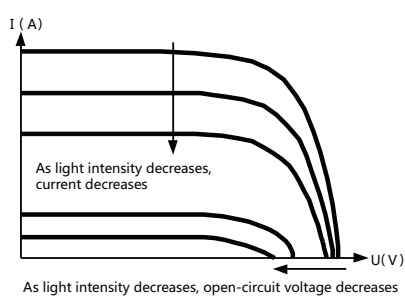

Figure 1-3 Relation between battery panel output characteristics and light intensity

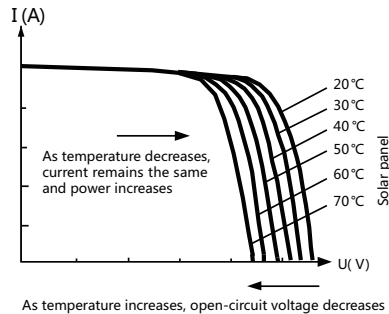

Figure 1-4 Relation between battery panel output characteristics and temperature

3. Technical Parameters

Product Type	MA2430N15	MA2440N15	MA2460N15	MA4830N15
Static power consumption	≤30mA	≤40mA	≤50mA	≤50mA
Battery type	USE/FLD/GEL/LI/SLD(Default)			
System Voltage	12V/24V			12V/24V/36V/48V
Battery's operating voltage range	8V-32V			8V-64V
Rated Charging Current	30A	40A	60A	30A
Maximum PV Input Current	27A	35A	53A	27A
Maximum solar panel power	400W/12V 800W/24V	520W/12V 1040W/24V	800W/12V 1600W/24V	400W/12V 800W/24V 1200W/36V 1600W/48V
Maximum PV Open-circuit Voltage	150V			
MPPT Operating Voltage Point Range	(Battery Voltage +2)~110V			
MPPT Efficiency	>99%			
Charging Conversion Efficiency	85%-98%(10%~100% of rated power)			
Rated load current	30A	40A	40A	30A
Load operation mode	Pure light-dependent control, light and time-dependent control, manual mode (default), debugging mode, normally opened.			
Parallel connection for charging	×	×	√	√
Charging voltage line loss compensation	×	×	√	√
Support full settings	√	√	√	√
Constant voltage output setting	√	√	√	√
Charging temperature compensation of lead-acid battery	√	√	√	√
Temperature protection	√	√	√	√
Overload/short-circuit protection	√	√	√	√
Load pre-start	√	√	√	√
TTL Communication	Baud Rate 9600kps			
RS485 Communication	One isolated RS485 communication port, with power output of 5V200mA, baud rate of 9,600kps by default and adjustable.		2 isolated RS485 communication ports, supporting parallel use, with power output of 5V200mA, baud rate of 9,600kps by default and adjustable.	
CAN communication	Optional (RV-C Protocol)			
Historical Data	Can store historical data of the past 300 days			
Backlight function	Light up if the key is pressed down, and automatically turn off in 20s if there is no key action			
Protection function	PV Overvoltage Protection, PV Reverse Connection Protection, PV Short-Circuit Protection, Nighttime Reverse Charge Protection, Input Limited Power Protection, Overtemperature Protection, Load Short-Circuit Protection, Load Overload Protection, Battery Supervoltage /Over-discharge Protection, Battery Reverse Connection Protection and Battery Terminal Short-Circuit Protection.			
Grounding Type	Co-negative design and negative grounding			
Operating ambient temperature range	-35°C~ 65°C (no derating within 45°C if well ventilated)			
Protection Grades	IP32			
Cooling mode	Natural Cooling			
dimension	260*216*83.2mm		260*216*98.5mm	
Weight	2.3kg		3.4kg 3.6kg	

4. Charging

4.1 Charging of lead-acid battery

Select such battery types as SLD/FLD/GEL/USE, and select the appropriate system voltage. As shown in Figure 8, the charging stages of lead-acid battery are: MPPT charging, constant voltage charging (equalizing/boost/floating charging), and current-limiting charging.

The constant voltage charging is divided into three stages: equalizing charging, boost charging and floating charging:

[MPPT charging] When the battery voltage does not reach the target constant voltage value, the controller conducts MPPT charging, when reaches, it automatically exits MPPT charging and switches to constant voltage charging (equalizing/boost/floating charging).

[Equalizing charging] Regular equalizing charging is good for some batteries. Equalizing charging is mainly to make the charging voltage of battery higher than the standard supplementary voltage, besides, it can vaporize the battery electrolyte to balance the battery voltage and complete relevant chemical reaction. Equalizing charging and boost charging are not repeated during one full charging to avoid excessive gas evolution or overheating of the battery.

Notes:

1) Since the equalizing charging of flooded lead-acid battery produces explosive gas, the battery compartment must be well ventilated.

2) Although the equalizing charging elevates the battery voltage, it may damage the level of sensitive DC loads, therefore, it is necessary to verify that the allowable input voltage of all loads in the system is greater than the set battery voltage value in equalizing charging.

3) Excessive charging and excessive gas evolution may damage the battery plate and cause the active substances on the battery plate to fall off. Besides, excessive high equalizing charging voltage or excessive long equalizing charging duration may damage the battery. Please set relevant parameters according to the specifications of the battery used in the system.

[Boost charging] The duration of boost charging is 2 h (default). When the duration reaches the set value, the system will switch to floating charging.

[Floating charging] Floating charging is the last constant voltage charging stage in the charging cycle of lead-acid battery. The controller keeps the charging voltage constant at the floating charging voltage. In the stage, charge the battery with a very weak current to maintain the battery in a fully-charged state. When the battery voltage is as low as the reconnect voltage of boost charging, the system will exit the floating charging stage and re-enter the next charging cycle.

4.2 Charging of lithium battery

Select such battery types as LI/USE LI, and select the system voltage from 12V/24V/36V/48V. As shown in Figure 9, the charging stages of lithium battery are: MPPT charging/boost charging/current-limiting charging.

[MPPT charging] When the battery voltage does not reach the target constant voltage value, the controller conducts MPPT charging to charge the battery with maximum solar power, when reaches, it automatically switches to boost charging.

[Boost charging] In the boost charging stage of lithium battery, when the battery voltage is lower than the boost charging voltage, the system conducts MPPT charging or current-limiting charging, when reaches, it switches to boost charging.

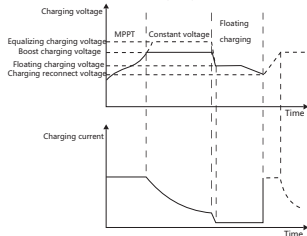

Figure 8 Lead-acid battery charging curve

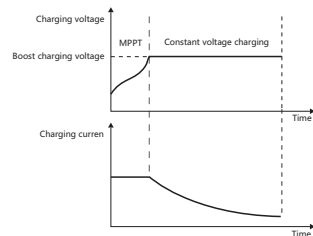

Figure 9 Lithium battery charging curve

4.3 Current limiting charging

1) When the charging current exceeds the set value, the system immediately limits the charging current within the set value range.

2) When the device is over-temperature, the system automatically conducts the over-temperature current-limiting charging.

5. Battery Temperature Sampling and Control

1) Connect the temperature sensor to the corresponding temperature interface to achieve the high and low temperature protection for the battery and the temperature compensation for the charging voltage of lead-acid battery (no temperature compensation for the lithium battery); if the temperature sensor is not connected, the default temperature is 25°C;

2) For the battery-related temperature protection/recovery value, please refer to the description in "15. System Alarm". The wiring method is shown in the figure:

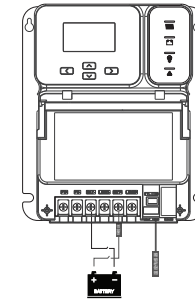

6. Loss Compensation of Battery Voltage Line (some models)

Since the cable diameter from the battery to the controller is too small, when the charging power is large, the voltage collected by the controller terminal will be higher than the actual voltage of the battery terminal, resulting in the battery being not fully charged; connecting the voltage compensation line can more accurately collect the battery terminal voltage, and timely output the voltage difference compensation, so that the battery terminal can get a more proper charging voltage.

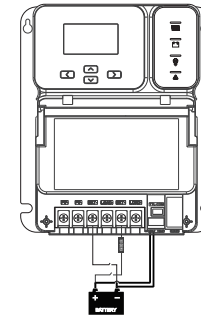

7. Load output

1) [Overload protection strategy]: 10s protection for the load greater than 1.25 times the rated load; 5s protection for the load greater than 1.5 times the rated load; 5s protection for the load greater than 2 times the rated load;

2) Please refer to "9.11~9.14" for relevant load settings.

8. Menu

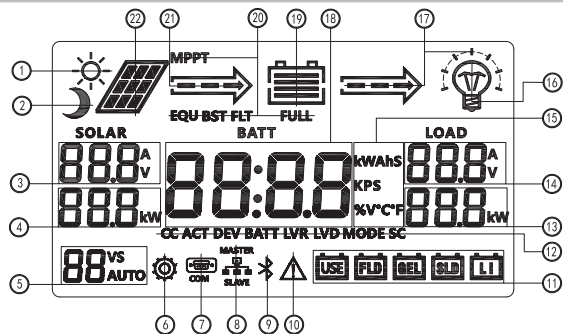

No.	Description	No.	Description
①	Daytime icon	⑫	Function character
②	Night icon	⑬	Load power
③	Solar panel current or voltage	⑭	Load voltage or current
④	Solar panel power	⑮	Unit
⑤	System voltage	⑯	Load icon
⑥	Parameter setting	⑰	Load on/oF icon
⑦	Communication icon	⑱	Battery voltage/current
⑧	Parallel communication	⑲	Battery
⑨	Bluetooth icon	⑳	Charging stage
⑩	System alarm	㉑	Charging state
⑪	Battery type	㉒	Solar panel

8.1 View menu

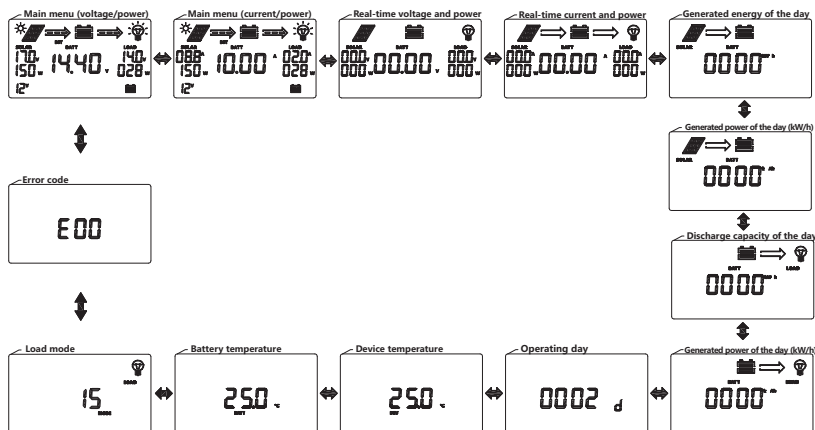

- 1) Alternative display between (voltage/power) and (current/power) on the main menu every 10s.
- 2) Short press [^] [v] to view the menu.
- 3) Long press [>] on any interface to enter the parameter setting page.

9. Parameter Setting

9.1 Battery parameter list

Battery parameters						
Battery type	Sealed lead-acid battery SLD	Gel lead-acid battery GEL	Flooded lead-acid battery FLD	Lithium battery LI	User-defined lead-acid battery USE	User-defined lithium battery USE LI
Setting/Voltage						
Overvoltage disconnect voltage ^①	16.0V	16.0V	16.0V	16.0V	Boost voltage +2V	Boost voltage +2V
Equalizing voltage ^①	14.6V	--	14.8V	--	9~17V	--
Boost voltage ^①	14.4V	14.2V	14.6V	14.4V	9~17V	9~17V
Floating voltage ^①	13.8V	13.8V	13.8V	--	9~17V	--
Boost restoring voltage ^①	13.2V	13.2V	13.2V	13.2V	9~17V	9~17V
Over-discharge restoring voltage ^①	12.6V	12.6V	12.6V	12.6V	9~17V	9~17V
Under-voltage alarming voltage ^①	12.0V	12.0V	12.0V	12.0V	9~17V	9~17V
Over-discharge voltage ^①	11.1V	11.1V	11.1V	11.1V	9~17V	9~17V
Over-discharge cutoff voltage ^①	10.6V	10.6V	10.6V	10.6V	9~17V	9~17V
Over-discharge delay	5s	5s	5s	5s	5s	5s
Equalizing charging interval	30days	--	30days	--	30	--
Equalizing charging duration	120min	--	120min	--	120	--
Boost charging duration	120min	120min	120min	--	120	--
Temperature compensation factor (mV/°C/2V)	-3	-3	-3	--	-3	--

①The above parameters are for 25T/12 V; when the system voltage is 12V/24V/36V/48V, the system will automatically multiply by 1/2/3/4 for relevant voltage points.

9.2 Parameter setting list

Setting No.	Function	Setting range	Default
n01	Battery type	FLD /SLD/GEL/LI/USE /USE LI	SLD
n02	Equalizing charging voltage ^①	9V~17V	Available for USE only
n03	Boost charging voltage ^①	9V~17V	Available for USE and USE LI only
n04	Floating charging voltage ^①	9V~17V	Available for USE only
n05	Charging reconnect voltage ^①	9V~17V	Available for USE and USE LI only
n06	Over-discharge reconnect voltage ^①	9V~17V	Available for USE and USE LI only
n07	Over-discharge voltage ^①	9V~17V	Available for USE and USE LI only
n08	System voltage	12/24/36/48/AUTO	AUTO
n09	Charging current	0-rated current (0: no charging)	Current
n10	Support full settings	0-10 A (0: turn the function off)	0
n11	Constant voltage output of lead-acid battery	on: constant voltage output in no load on the battery terminal oF: no output in no load on the battery terminal	oF
n12	Light control voltage ^①	5-11V	5V
n13	Light control delay	60~3600s	60s
n14	Load mode	0-17	15
n15	Load short-circuit protection	on: open load short-circuit protection oF: close load short-circuit protection	on
n16	Load prestart time	1-6s	2s
n17	Over-discharge delay	1-60s	5s
n18	Temperature unit	°C: Celsius/°F: Fahrenheit	°C
n19	RS485 communication baud rate	1200~115200kps	9600kps
n20	Device address	1-247	1
n21	RS485 communication interface function selection	485C: for communication/ 485P: for parallel operation	485C
n22	System reboot	F01	Function key
n23	Factory data reset	F02	Function key
n24	Clear historical	F03	Function key

Note:

①: 12V/24V/36V/48V battery system will automatically multiply by 1/2/3/4 according to the set value to get the actual control value.

9.3 Battery type (n01)

Please refer to "9.1 and 9.2" for setting.

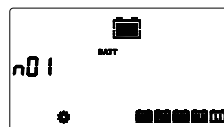

9.4 Equalizing charging\boost charging\floating charging\charging reconnect voltage\over-discharge reconnect voltage\over-discharge voltage (n02-n07)

n02-n07 battery type settings are only displayed for "USE" or "USELI" options, and other battery types are not displayed.

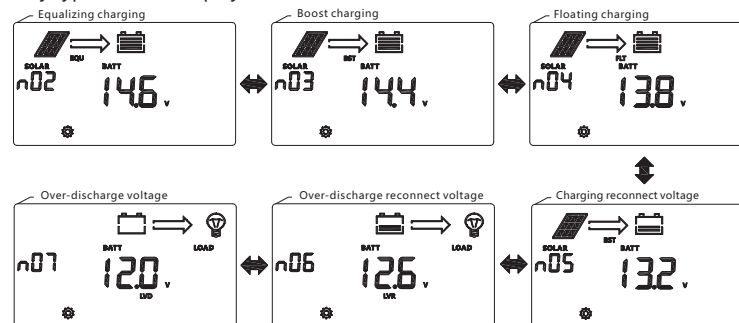

9.5 System voltage (n08)

When the system voltage changes, the system voltage icon on the main page will flash, prompting the user to reboot for effective operation.

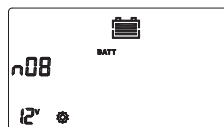

9.6 Charging current (n09)

- 1) [No charging] Set 0
- 2) [Limit charging current] Set an arbitrary value from 1 to rated charging current

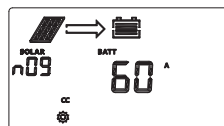

9.7 Full-charging setting (n10)

- 1) [oF] Set 0
- 2) [on] Select the appropriate current value between 1-10A

Full-charging condition: When the constant voltage charging duration of lithium battery reaches the set duration or the lead-acid battery is in float charging after the equalizing charging or the boost charging is finished, and the charging current is less than the set current value, the system will stop charging after 1 minute, and the "FULL" icon will light up on the screen.

Charging recovery condition: The battery voltage is less than the boost charging reconnect voltage, the system will recover charging, and the "FULL" icon will light off on the screen.

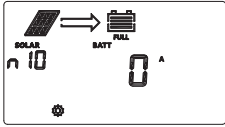

9.8 Lead-acid battery constant voltage output (n11)

Constant voltage output in no load on the battery terminal

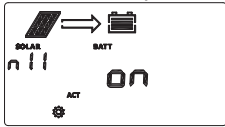

No output in no load on the battery terminal.

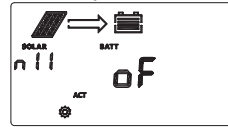

9.9 Light control voltage (n12)

- 1) [Light control on] :The solar panel voltage is less than 5V*N
- 2) [Light control of] :The solar panel voltage is greater than 6V*N
(N=1/2/3/4)



9.10 Light control delay (n13)

Minimum duration required to meet the light control on or off condition.



9.11 Load mode (n14)

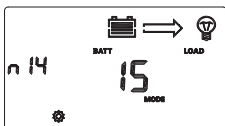

LCD screen number	Load mode	Description
0	Pure light control	After the duration during which the solar panel voltage is less than the light control ON voltage is greater than the light control delay, turn on the load; after the duration during which the solar panel voltage is greater than the light control OFF voltage is greater than the light control delay, turn off the load.
1~14	Light control+time control 1h-14h	After the duration during which the solar panel voltage is less than the light control ON voltage is greater than the light control delay, turn on the load. After the load has been operating for the set time, turn off the load. After the duration during which the solar panel voltage is greater than the light control OFF voltage is greater than the light control delay, turn off the load (light control prevails).
15	Manual mode (default)	If the solar panel voltage is less than the light control ON voltage, immediately turn on the load; if the solar panel voltage is greater than the light control OFF voltage, immediately turn off the load
16	Debugging mode	Short press [>] key to turn on/off the load (not affected by light control)
17	Normal on mode	The load is always on (In case of battery over-voltage, battery over-discharge, load short-circuit, overload, battery over-temperature, or battery low-temperature, the load will turn off the output)

9.12 Load short-circuit protection switch (n15)

Some inductive loads or capacitive loads will produce high current at the moment of start-up, which will easily trigger load short-circuit protection, resulting in failure to turn on the load. This function can be disabled when the system cannot be started (Note: After this function is disabled, short circuit at load side of the controller is prohibited!)

Enable load short-circuit protection

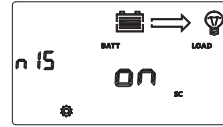

Disable load short-circuit protection

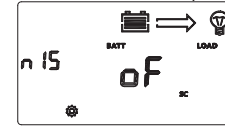

9.13 Load pre-start time (n16)

When the load is turned on, the load is precharged to prevent short-circuit protection caused by false contact.

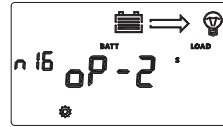

9.14 Over-discharge delay (n17)

After the battery voltage is lower than the over-discharge voltage, the controller turns off the delay time for the load. (Note: Only the custom battery type can be set)

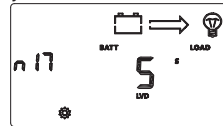

9.15 Temperature unit (n18)

Celsius scale: °C



Fahrenheit scale: °F



9.16 RS485 communication baud rate (n19)

The RS485 communication baud rate can be modified according to actual needs.



9.17 Device address (n20)

The device communication address can be modified according to actual needs.



9.18 RS485 function selection (n21)

Set to communication mode



Set to parallel mode

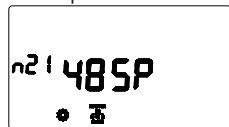

9.19 System reboot (n22)

Press [>]: "F01" will flash; press [>] again: the controller will reboot.

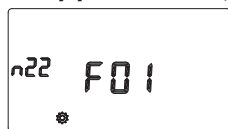

9.20 Reset controller (n23)

Reset the controller to factory default settings in accordance with "9.19".



9.21 Clear historical data (n24)

Clear the historical data of the controller in accordance with "9.19".



10. Parallel Application

The parallel function means that multiple controllers charge a battery pack collectively, each controller has an independent solar panel and connects to each other with RS485 communication lines, and the master manages the charging state/stage/target constant voltage value and other parameters of the slaves in a unified manner. Parallel charging can break the power limit of a single device, and multiple parallel devices can meet the demand for greater charging power. After setting to the parallel mode, the master regularly sends management packets to the slaves (automatically assigned by the master) through RS485 bus.

- 1) Set non-repeating device addresses from 1 to 16 for each device in accordance with "9.17";
- 2) Set to "parallel mode" as per "9.18";
- 3) See "21.2" for system wiring.

11. TTL Communication

- 1) Default baud rate: 9,600 bps, check bit: none, data bit: 8 bit, stop bit: 1 bit
- 2) Communication power supply output specification: (12 V±3 V)/: 100 mA

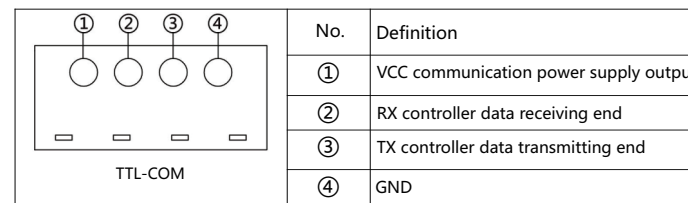

12. RS485 Communication



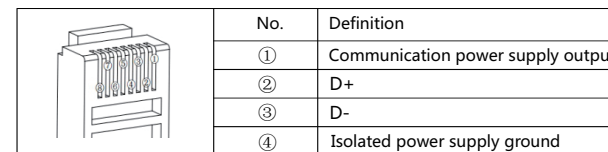

- 1) Default baud rate: 9,600 bps, check bit: none, data bit: 8 bit, stop bit: 1 bit
- 2) Interface type: RJ45, communication power supply output specification: 5 V/200 mA
- 3) Isolated RS485 communication interface, set to communication mode or parallel mode
- 4) RS485 communication line sequence definition:

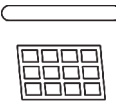

13. Keys

Key	Function
<	[Short press] this key to return to the previous menu/undo the modification of the current item [Press and hold] this key to jump to the system code page/lift the load short-circuit output once in case of load short-circuit
∧	[Short press/Press and hold] this key to page up/set data increment
∨	[Short press/Press and hold] this key to page down/set data decrement
>	[Press and hold] to enter/exit parameter setting [Short press] to turn on/off the load (manual mode)/perform parameter modification and confirmation

14. Indicator

Indicator	Light state	Meaning
	Always ON	MPPT charging
	Slow flash	Boost charging
	Single flash	Floating charging
	Fast flash	Equalizing charging
	Double flash	Current-limited charging
	OFF	No charging
	Always ON	Normal battery
	Slow flash	Battery over-discharge
	Fast flash	Battery over-voltage
	OFF	Load OFF
	Always ON	Normal load output
	Fast flash	Overload/Short-circuit
	OFF	Normal system
	Always ON	System alarm

15. System Alarms

System alarm	Meaning	Description
E0	Normal system	No action
E1	Battery over-discharge	Turn off load output, after the battery voltage rises to the over-discharge reconnect voltage, relieve over-discharge to restore load output
E2	Battery over-voltage	Stop charging, check and find out the cause of high battery voltage. The charging will be automatically restored after the battery voltage is lowered
E3	Battery under-voltage warning	Battery voltage below the under-voltage warning threshold, warning only
E4	Load short-circuit	Turn off load output
E5	Load over-current	Turn off load output, and perform delay protection by a multiple of rated current
E6	Device over-temperature protection	Thermostat control will be turned on when the internal temperature is above 68°C, and resumed when it is below 67°C; charging will be stopped when the internal temperature is above 85°C, and resumed when it is below 75°C
E7	Battery over-temperature protection	Charging will be stopped when the battery temperature is above 65°C, and automatically resumed when it is below 60°C
E10	Solar panel over-voltage	Charging is stopped, and then automatically resumed when the solar panel voltage is below the safety limit
E15	Lead-acid battery disconnected	Lead-acid battery mode, damaged or disconnected battery
E16	Battery high temperature discharging protection	Load output will be turned off when the battery temperature is above 75°C and resumed when it is below 70°C
E17	Battery low temperature discharging protection	Load output will be turned off when the battery temperature is below -35°C and resumed when it is above -30°C
E18	Overcharge protection	Charging is stopped and then resumed 10s after the battery voltage is lowered
E19	Battery low temperature charging protection	Charging will be stopped when the battery temperature is below -35°C and resumed when it is above -30°C
E30	Charging and discharging disabled by system setting	Disabled by default (set relevant registers by protocol)
E31	Charging over-voltage, over-current and reverse current protection, etc.	The device will be automatically resumed after the exception is released

16. Common Problems and Solutions

Phenomenon	Troubleshooting
The indicator and LED light are off	Check whether the battery and solar panel are properly connected and whether the LCD connection cable has a poor connection
There is voltage in the solar panel, there is no voltage output from the battery side, and code E1/E15 is displayed	The battery is not detected at the lead-acid battery end, there is no voltage output from both ends of the battery. Connect the battery to return to normal or turn on the lead-acid battery activation switch
12V/24V/36V/48V normal voltage battery is connected, the battery icon on the LCD screen flashes slowly, and code E1 is displayed	Check the battery system voltage, or set it to automatically identify and reboot the controller
On-screen system voltage 12/24/36/48V icon flashes	Set system voltage change, prompting the user to reboot the system for the change to take effect
The controller fails to charge	Check whether there is wrong wiring, whether the solar panel voltage exceeds the rated value, whether the battery is over-voltage, whether the LCD screen displays any error code of internal over-temperature, external over-temperature, external lithium battery low temperature, or lead-acid battery open-circuit, and whether it displays E7/E10, etc.
Charging power does not reach the rated value	Perform system current limiting and thermostatic control; Check to see if the system has reset charging current
Other problems or exceptions difficult to resolve	Try to reboot (F01) or reset controller (F02), and reset relevant parameters again as per system configurations. Be careful!
Fail to start some loads	Try enabling the load short-circuit function after checking that the wiring is correct
The screen displays "FULL", and charging stops	Charging stops as the charging cut-off current conditions are met. When the voltage is below the boost charging reconnect voltage, the charging will be automatically resumed
There is a system alarm code	See "15. System alarms" for details

17. Product Installation

17.1 Precautions for Installation

- ◆ Be very careful when installing the battery. Wear protective glasses when installing the flooded lead-acid battery. Once contacting the acid solution of battery, please rinse with clear water in time.
- ◆ Avoid placing any metal object near the battery against short-circuiting.
- ◆ Acid gas may be generated when the battery is charged so as to ensure good ventilation of surroundings.
- ◆ The battery may produce combustible gas, please stay away from sparking.
- ◆ Direct sunlight and rainwater infiltration should be avoided during the outdoor installation.
- ◆ Virtual junctions and corroded wires may cause great heat, melt the insulation of wire, burn the surrounding material, and even cause fire. Therefore, it is necessary to ensure that all connectors are tightened, and wires are preferably fixed with ties to avoid loose connectors caused by shaking of wires during mobile applications.

- ◆ Once the System is connected, the output voltage of the component may exceed the safe voltage of human body. In the process of operation, attention shall be focused on using insulating tools and ensure that hands are dry.
- ◆ The battery terminals on the Controller can be connected with either a single battery or a group of batteries. Subsequent instructions in the Manual are for use with a single battery, but also applicable to systems with a group of batteries.
- ◆ Please follow the safety recommendations of battery manufacturers.
- ◆ The System's connection wire shall be selected according to the current density no more than 4A/mm².
- ◆ Ground the Controller earth terminal.
- ◆ It is forbidden to connect the battery in reverse, which will cause irreversible damage in the process of installation.

17.2 Installation steps

Wiring and installation must meet the requirements of national and local electrical codes. Wiring specifications shall be selected according to the rated current, generally, 5A/mm².

Step 1: Select an installation place

Avoid installing the controller in direct sunlight, high temperature and areas prone to water entering, and ensure that the environment around the controller is well ventilated.

Step 2: Fix suspension screws

Mark the mounting position according to the mounting dimensions of the controller, drill two mounting holes of suitable size at the two marks and fix the screws on the two mounting holes.

Step 3: Fix the controller

Align the controller fixing holes with the two pre-fixed screws, hang the controller up, and then fix the two screws below.

Step 4: Open the front cover of the controller, wiring, and then close the front cover.

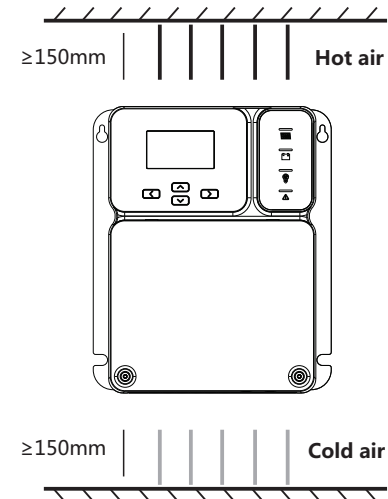

18. Protection Functions

- ◆ Device over-temperature protection
When the internal temperature of the controller exceeds the set value, the charging power will be automatically lowered or the charging will even be stopped, further slowing the rise in internal temperature of the controller.
- ◆ Battery over-temperature protection
Battery over-temperature protection requires an external battery temperature sampling sensor. Charging will be stopped when the battery temperature is detected to be too high, and will be automatically resumed when the battery temperature drops to 5°C below the set value for 2s.
- ◆ Input over-power protection
When the battery panel power is greater than the rated power, the controller will limit the charging power within the rated power range to prevent excessive current from damaging to the controller, and the controller will enter current-limited charging.
- ◆ PV input side too high voltage protection
When the voltage at the input side of the PV array is too high, the controller will automatically cut off PV input.
- ◆ PV input reverse-connection protection
The controller will not be damaged if the polarity of the PV array is reversed and will return to normal after the wiring error is corrected.
- ◆ Reverse charging protection at night
Prevent the battery from discharging through solar battery at night. Special note: Battery reverse connection protection is not supported

19. System Maintenance

In order to maintain the optimal operating performance of the controller for a long time, it is recommended that the following items are regularly checked.

- ◆ Make sure that the airflow around the controller is not blocked, and remove any dirt or debris from the radiator.
- ◆ Take corrective actions timely after any fault or error is found.
- ◆ Check whether there is corrosion, insulation damage, high temperature or burning/discoloring at terminals, case distortion, etc. and repair or replace timely if any.
- ◆ Check whether there is any exposed or broken wire or wire with poor insulation, and repair or replace timely if any.
- ◆ Check whether there is dirt, nesting insects or corrosion, and clean timely if any.

Warning: There is a risk of electrical shock! Before carrying out checks or operations above, make sure that all power supplies for the controller are disconnected! Any non-professional personnel is prohibited from carrying out such operations.

20. Product Dimensions

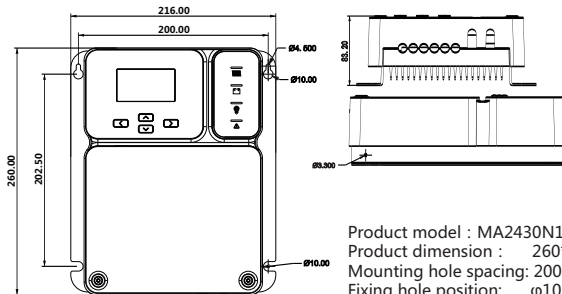

Product model : MA2430N15、MA2440N15
Product dimension : 260*216*83.2mm
Mounting hole spacing: 200 mm
Fixing hole position: φ10 mm

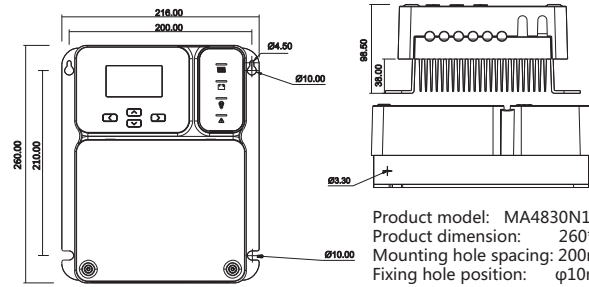

Product model: MA4830N15、MA2460N15
Product dimension: 260*216*98.5mm
Mounting hole spacing: 200mm
Fixing hole position: φ10mm

21. System Wiring Diagram

21.1 Single application wiring diagram

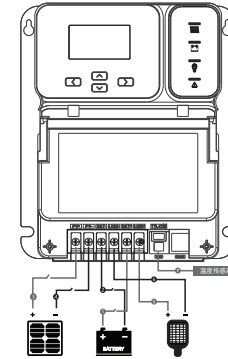

21.2 Parallel application wiring diagram

